

SOLUTIONS
FOR ALL
SPACES

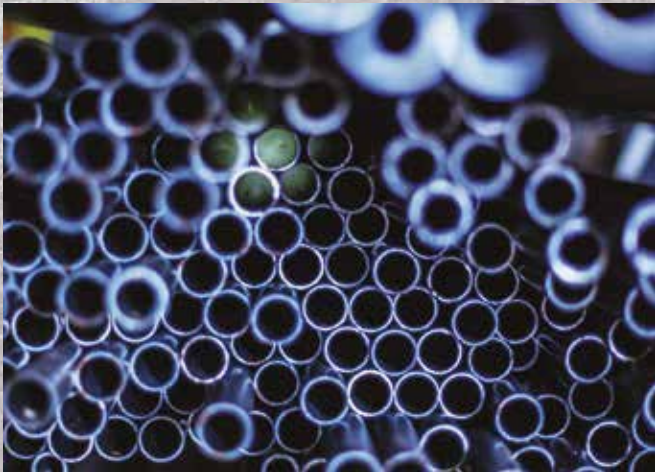
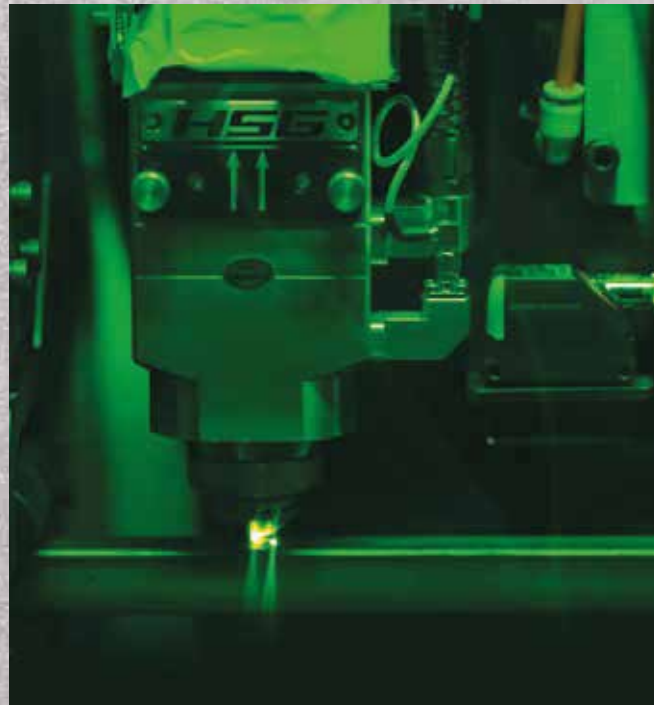

Cutting of tubes and profiles
(max. Ø90 mm)

Bending of tubes and profiles
with bending machine and 3D
CNC bending machine
(max. Ø60 x 5 mm)

MIG/MAG welding
by „hand“ and also
with welding robots

Carpentry works
with wide range of raw
material (HPL boards,
chipboard, plywood, etc.)

Electrostatic plastic powder-coating
(max. size 800x1200x2000 mm).
The coating can be made for
outdoor or indoor use.



HEIGHT
ADJUSTABLE

PRODUCT COLLECTIONS

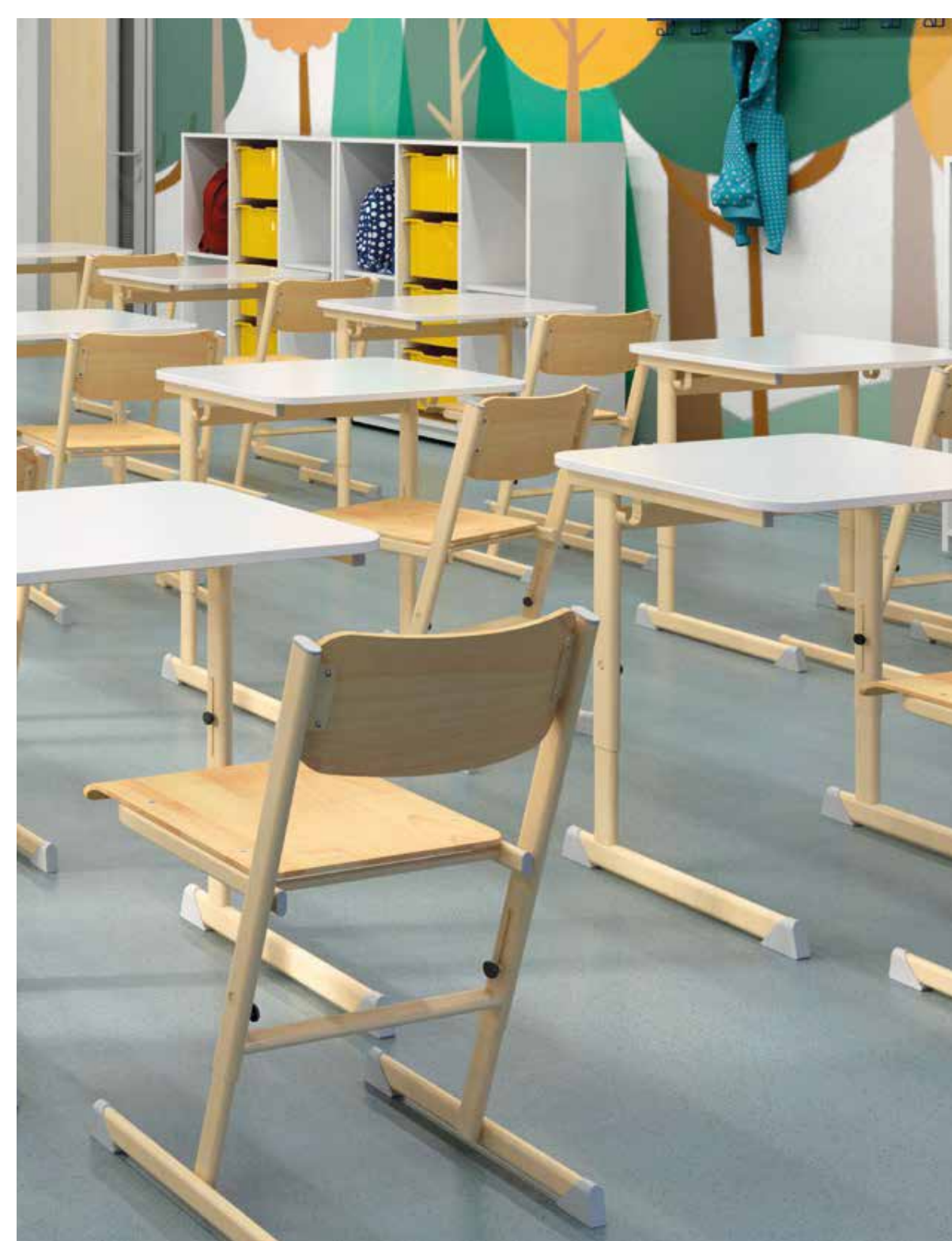

HEIGHT ADJUSTABLE

FURNITURE FOR YOUR INSTITUTION

By height adjustability of chairs and desks the optimum sitting comfort can be adapted to various students heights. They are stackable, makes the use more versatile, and the space can be used more efficiently.

Nowadays in addition to frontal teaching, group work, games or other events that require movement are more common.



FLEX JUSTY

This is one of our newest product lines. During the development we have focused on the high variability of usage, and the result gives several options of placing tables in different forms together.

FLEX DESKS FOR ONE OR TWO PERSONS



paintable end cap element

optional bag hook

optional castors with brake



with optional Gratnells drawer

height adjustment according to age group



*teacher's desk
with drawers*



*adjustable height
school chair*



*school chair,
with adjustable
height footrest*



office chair

PRODUCTS



JUSTY TRAPEZOID AND HEXAGON

The height adjustment function of our Justy trapezoid and hexagon tables are built on telescopically sliding tubes.

Adaptive furniture for project based learning, student-centred and active learning.

Because of the characteristics like stacking, row formation and height adjustability of our trapezoid and hexagon desk your space can be reorganised in moments to the desired configuration.

IDEAS FOR SPACE PLANNING

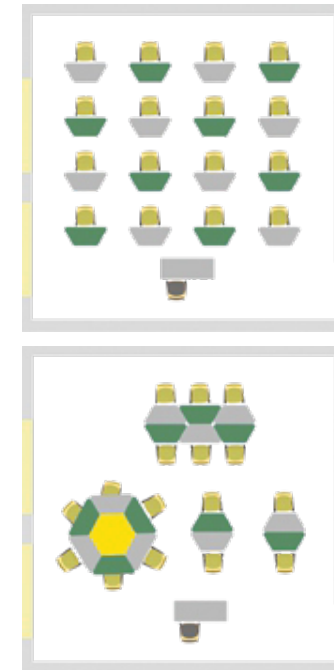

JUSTY TRAPEZOID DESK
2 seats, height adjustable,
stackable, arrangible in a row



JUSTY TRAPEZOID DESK
with castor, 1 person, adjustable,
stackable, arrangible in a row



JUSTY HEXAGON DESK
for 1 person TRAPEZE desks,
height adjustable

DESKS



KEX DESKS FOR ONE OR TWO PERSONS

This collection has a height adjustable desk and a stackable chair which is made of 38x20 mm flatoval steel tube, the seat and backrest are made with form pressed plywood.

Desk legs are made by a 50 x 25 mm flatoval tubes.

The legs of the desks and chairs are height adjustable with a telescopic „tube-in-tube” solution.

height adjustable by age group, stackable chair frame

beech plywood seat and backrest

table top with rounded corners

height adjustable table frame by age group

plastic floor gliders

Optionally available, chair or book holder rack

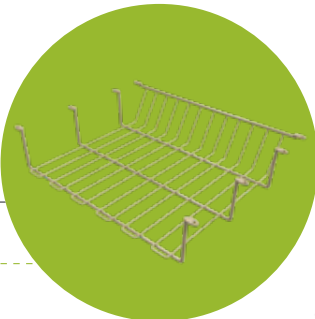

teacher's desk with drawers



teacher's chair, upholstered



school chair

PRODUCTS

FRONTAL EDUCATION





ADVANTAGES OF FIXED HEIGHT FURNITURE IN FRONTAL EDUCATION?

Frontal class work strengthens the competitive spirit on a given topic, and prepares for debates.

The typical teaching methods of this type of organisation are lecture, demonstration and explanation, is assisted by our learning furniture.

FIXED HEIGHT
PRODUCT COLLECTION



The table frame is made of 50x25 mm flat oval steel tubes, welded, with bag hooks, and powder coated surface, finished with plastic leg gliders and end caps.

It is made according to the desired standard age group sizes.

The table top measures 70x50 cm or 130x50 cm, available in different materials.

Chair frame is made of 38x20 mm flat oval tubes with welded construction, powder coated surface, plastic foot gliders and end caps. The chairs are stackable, or can be placed in the table's book holder rack.

KEX FIX DESKS FOR ONE OR TWO PERSONS



PRODUCTS



GEO LINEA DESKS FOR ONE OR TWO PERSONS

Harmonic lines, various product range and colour options.

A proven furniture range, that fits in the modern look of a premium class room. The rounded table corners provide increased safety.

The robust frame construction and multiple chairs to choose from, makes it easy to be tailored to the needs of the users.

Cost-effective solution for premium school furniture category.

The desk's solid frame structure is identical to the Geo base model, and harmonious with all the chairs in the collection.

safe, rounded corners

Immersed seating surface

Optionally available, chair or book holder rack

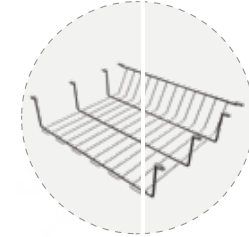

50x50mm flatoval steel pipe



*teacher's desk
with lockable cabinet*



school chair



school chair



school chair



school chair



school chair



school chair

PRODUCTS



Unique look, rounded table edges.
Made according to the desired
standardized age group sizes.

The desk frame is made of 50x25
mm flatoval steel pipe bent to "C"
shape format. Powder coated finish
and plastic floor gliders.

The chair with a cantilevered design
can also be placed under the table
into the book holder rack.

The table top measures 70x60 cm
or 130x60 cm, available in various
materials. Also available with bag
hook on request.

Optionally available,
chair or book holder rack

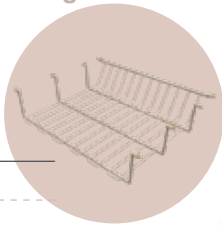

GEO SPECIAL DESKS FOR ONE OR TWO PERSONS

Rounded corners,
safer shape!

Immersed seating surface

Book holder rack:
also the chair can be placed
in it for easier floor cleaning

60x20mm rectangular steel pipe



school desk



school chair



school chair



*teacher's chair,
upholstered*



*teacher's chair,
upholstered*



teacher's chair



*teacher's chair,
upholstered*

PRODUCTS



Classic shape, high stability.

The Atlas table frame is made of 50x25 mm flatovaland tube, the chair frame made of 30x15 mm steel pipes with anti-slip plastic end caps.

The standard desk tops are made of 18 mm laminated chipboard with a 2 mm ABS edge sealing, in your choice of colour.

Optionally, with book holder rack or book holder box.

ATLAS DESKS FOR ONE OR TWO PERSONS



teacher's desk with drawer



school chair

school chair

teacher's chair

school chair

school chair

teacher's chair

PRODUCTS

GROUP EDUCATION





FIXED HEIGHT PRODUCT COLLECTIONS

WHAT ARE THE ADVANTAGES OF FIXED HEIGHT FURNITURES IN GROUP TEACHING?

For smart classrooms and digital environments our furniture collections can be found in this topic.

Our aim is to support you to find educational environments that will help to create more interactive and flexible learning spaces by using our furniture.



Collaborative, flexible spaces,
many opportunities!

Frisbee desks are designed
for group work. Desks can be
rearranged in several layout as
required.

Teaching and learning has
definitely changed.

Our furniture supports the goal of
being a highly collaborative, and
offers flexible space for students
and teachers.

IDEAS FOR SPACE PLANNING



FRISBEE DESKS, RIGHT OR LEFT

● rounded table top corners

● height levelling
plastic insert glides



● robust frame,
30 mm diameter steel tube

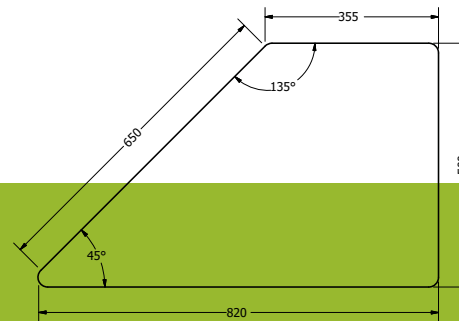

FRISBEE RIGHT SIDE
student desk

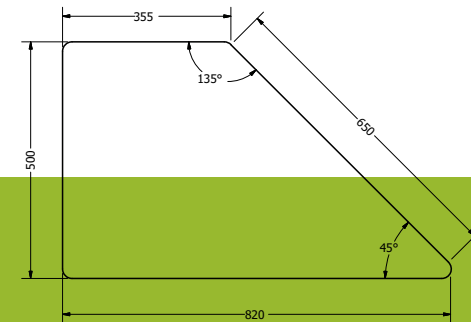

FRISBEE LEFT SIDE
student desk

DESKS



High mobility brings versatility!

Our ongoing furniture developments create space, allow institutions to find the most suitable solution for them, even multifunctional school furniture for all day education ensure a smooth running of the whole day.

Essential for modern learning is the need for differentiation in the classroom, which implies that school furniture must meet both individual and group work.

For this differentiation, the furniture is arranged spatially, this requires a need of ease of movement and combination, functionality, ergonomics, and rangeability.

FLEX SINGLE AND TWO PERSON DESKS AND FLEX CHAIRS



*teacher's desk
with Grattells drawers*



school chair



teacher's chair



school chair



teacher's chair



school chair



teacher's chair

FURNITURE FAMILY



TRAPEZOID AND HEXAGON

Our stackable trapezoid and hexagon tables can be easily configured in a row, offering limitless possibilities for active learning and teaching that demand flexibility.

We understand that adapting to student-centered learning is crucial, which is why our furniture is designed with this in mind. The stackable trapezoid and hexagon desks can be rearranged in a matter of moments, providing unmatched versatility.

Flex, Trapezoid and Hexagon desks support the improvement of student communication skills, conflict management and enhanced student productivity.

IDEAS FOR SPACE PLANNING



HEXAGON DESK
stackable



TRAPEZOID DESK
1 person,
sortable in row



TRAPEZOID DESK
with castors, 1 person,
sortable in row



TRAPEZOID DESK
1 person, stackable,
sortable in row



TRAPEZOID DESK
with castors, 1 person,
stackable, sortable in row

DESKS



SMART CLASSROOM

Innovative and flexible!

Our smart classroom solutions bring together furniture, tools, software, and teaching methods in perfect harmony.

Teaching and learning have no obstacles with our smart classroom furniture, making the work enjoyable.

In the classrooms of the 21st century, we foster critical thinking, creativity, teamwork, digital competence, hands-on experiences, and active learning.

IDEAS FOR SPACE PLANNING



hidden castor feet



HEXAGON DESK
smart classroom



TRAPEZOID DESK
smart classroom

TABLES



Individual and group work has never been so easy!

Introducing Kaleido Puzzle furniture with multiple variations.

Inspired by the variety of kaleido puzzles, our Kaleido collection features desks and chairs with convex and concave shapes, offering flexible room arrangements for group work.

IDEAS FOR SPACE PLANNING

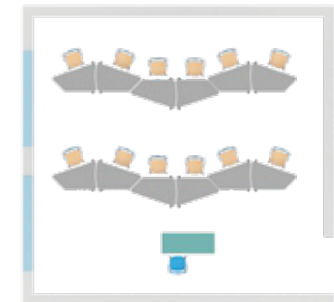
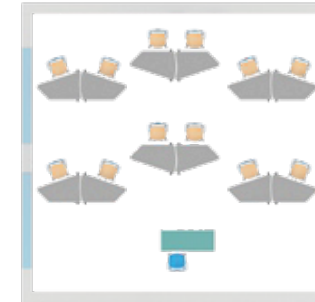
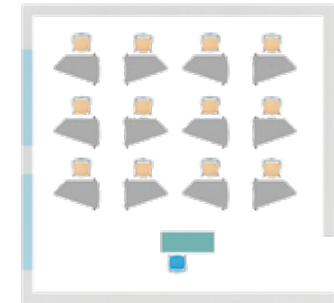
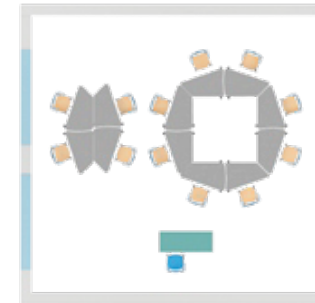

height adjustable



single student desk



single student desk



*teacher's chair,
upholstered*



school chair

FURNITURE FAMILY



Discover our Pitagoras tables designed for versatile communal spaces like libraries, language instruction areas, and study rooms, where the ability to quickly change the layout is crucial for accommodating both individual and group activities.

Thanks to the castors, our furnitures can be effortlessly relocated.

Due to the durability of HPL material, you won't have to worry about tabletop edges breaking or splitting when arranging and moving the tables. Plus, the table surfaces are highly resistant to scratches, ensuring long-lasting quality.

IDEAS FOR SPACE PLANNING

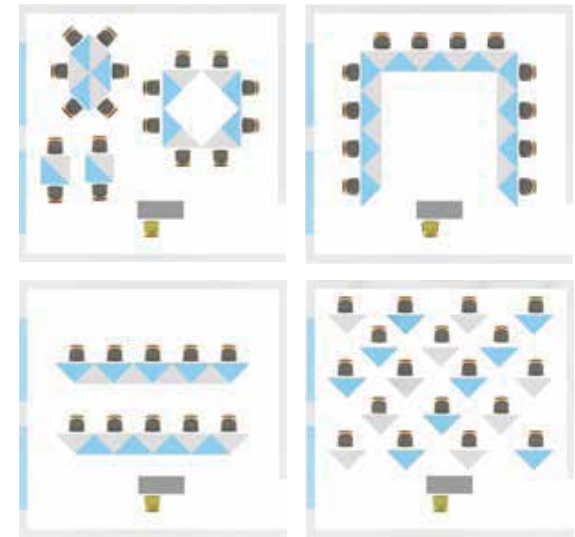

student desk



student desk



student desk

DESKS



Inventive and dynamic.

Create your ideal learning environment with our Puzzle Wave desks.

Enhance modern learning and group projects with quickly and easily variable desks

IDEAS FOR SPACE PLANNING

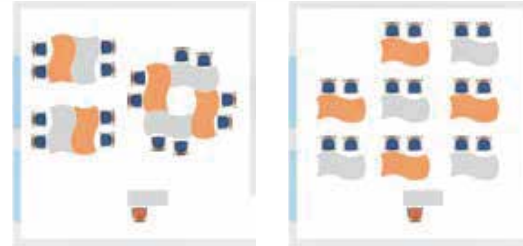
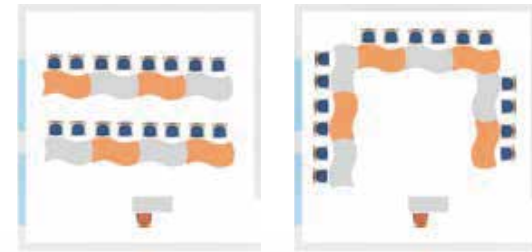

student desk



student desk

DESKS

A modern classroom with a bright yellow locker bank on the left. The room is furnished with white desks and green chairs arranged in rows. A projector is mounted on the ceiling, and a yellow door is visible in the background. The text "TEACHERS DESKS AND CHAIRS" is overlaid at the bottom.

TEACHERS
DESKS AND CHAIRS



WELCOMING --- SPACES FOR TEACHERS TO WORK INDIVIDUALLY AND IN TEAMS

We have also designed furnitures for teachers' rooms, in mind where teachers can relax, have a coffee, but most of all, where they can prepare their lessons, correct the exams or have a meeting with their colleagues.

The furnishing of usually cramped and crowded spaces with practical and multifunctional furniture is a crucial point. With our innovative products workstations, ergonomic seating and desks with drawers can be integrated.



upholstered



upholstered



upholstered



upholstered



upholstered



upholstered



upholstered



footrest, upholstered



upholstered, skid legs



upholstered, skid legs



upholstered



upholstered

TEACHER'S CHAIRS



teacher's desk



teacher's desk



double-sided teacher's desks



double-sided teacher's desks



teacher's desk

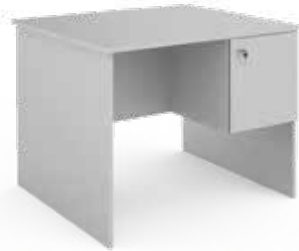

double-sided teacher's desks



double-sided teacher's desks



with drawers teacher's desk



double-sided teacher's desks



teacher's desk



double-sided teacher's desks



with castor cabinet teacher's desk

TEACHER'S DESKS





FLEX CABINETS WITH GRATNELLS DRAWERS

STRUCTURED PRACTICAL AND WELL ORGANIZED STORAGE

Our FLEX cabinets are made up of modular units. With our products you can design your practical storage systems for classrooms.

Well-organised filing and easy to use storage.

Some models are available with castors which allows you to rearrange your spaces in a moment.

In case of cabinet corpus, you have the choice of various laminate colours. 7 different colours are available to choose from, when it comes to plastic Gratnells drawers.





CLASSIC CABINETS

OUR SPECIALITY

CABINETS MADE FOR DIFFERENT STORING PURPOSES

Whether classrooms or offices, our multifunctional lockers are a perfect fit.

The body and doors are made of 18 mm laminated chipboard with ABS edge sealing. With fixed height shelves, back panel made of 4 mm white HDF board.

Fitted with handle and lock.

SCHOOL BOARDS

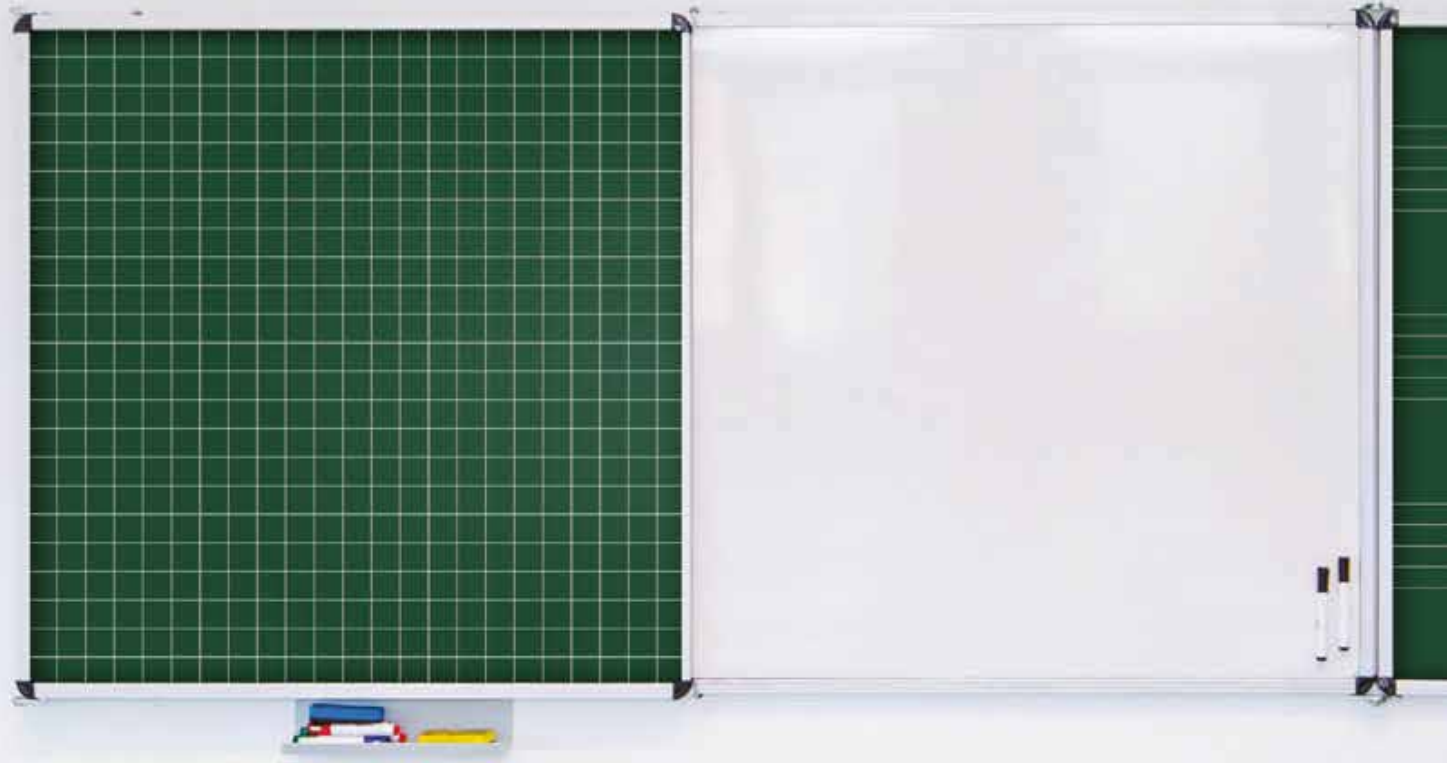



SCHOOL BOARDS

ESSENTIAL TOOLS FOR EDUCATION

School boards and accessories are crucially essential to aid visual demonstration in classrooms.

We offer a variety of models from squared to double winged boards as well as mobile versions, that are suitable for both chalk and marker use, so every educational institution can find what they need.

Wall boards, board stands and pedestal boards are colouring our product range as well.

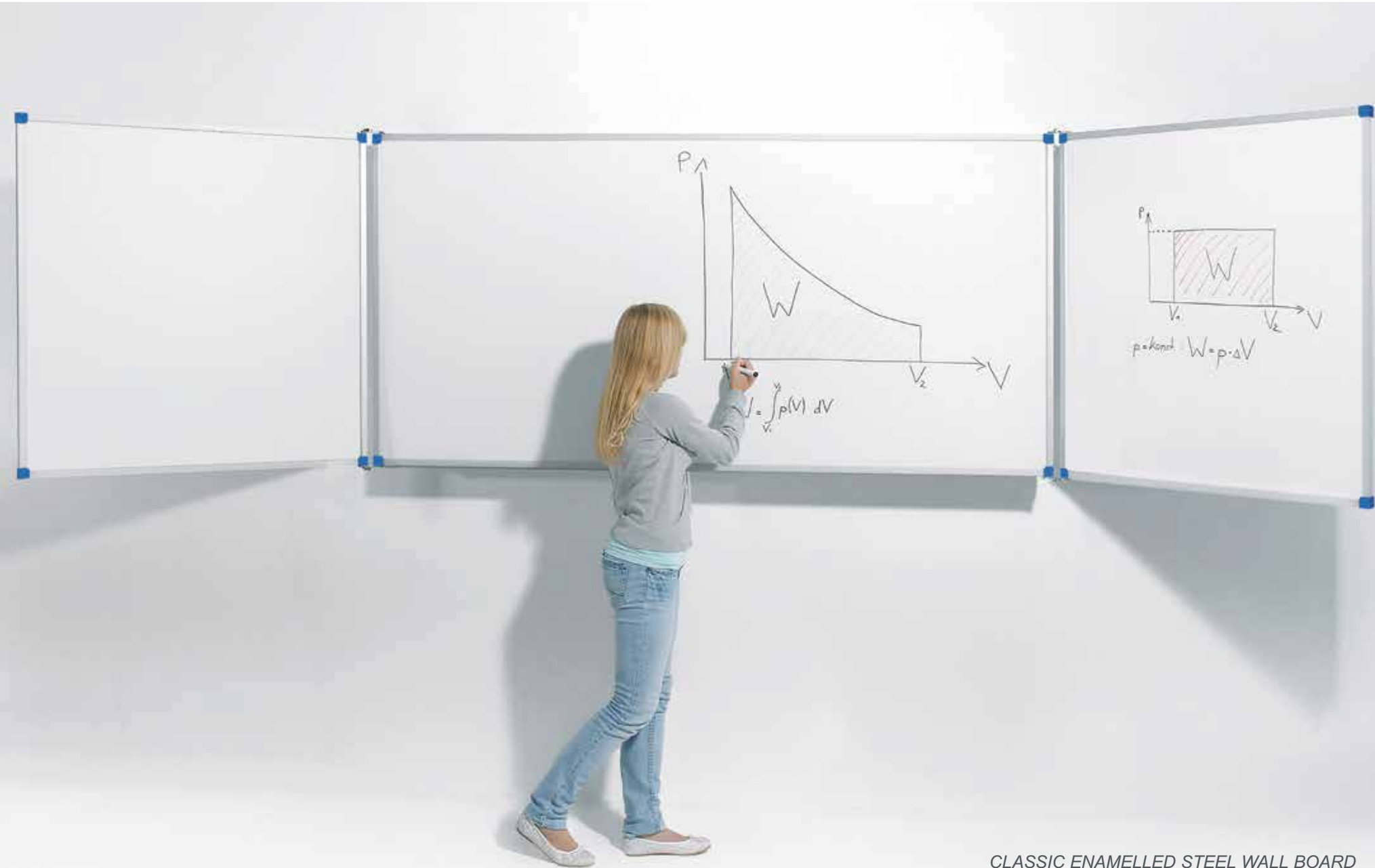

CLASSIC

CLASSIC ENAMELLED STEEL WALL BOARD
Side-winged

The boards are fixable with screws and dowels.

Can also be mounted on a mobil stand, making the board surface rotatable.

MODELS THAT CAN BE WRITTEN WITH MARKER PEN AND CHALK,
ALSO AVAILABLE IN SQUARE AND DOUBLE WING VERSIONS



The **Classic Board** frame is 15 mm wide powder coated aluminium, Made of U profile, closed with plastic components at the corners.

The ceramic-steel and enamel-steel chalkboards come with **chalk holders**.



CLASSIC BOARD
on a mobile stand

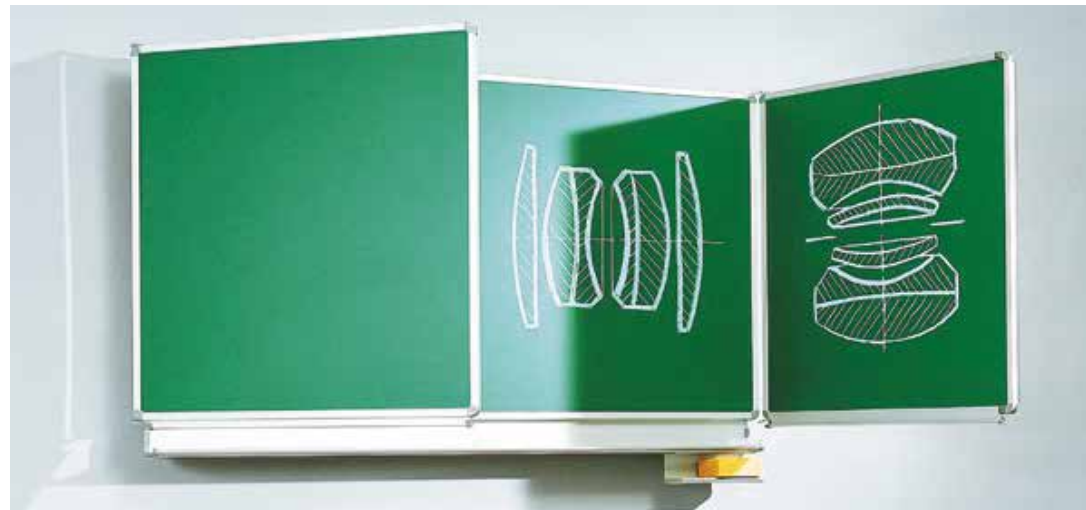

CLASSIC CERAMIC STEEL WALL BOARD
side-winged

BOARDS

VARIO



*VARIO WALL BOARD
vertically movable*

The Vario counterweighted wall board is attachable to the ground or wall by fixing the column stand with hidden screws, or by using a console.

MULTIPLE SURFACES - SIMULTANEOUS MOVEMENT, EVEN IN OPPOSITE DIRECTIONS



*VARIO WALL BOARD
with electric column stand*



*VARIO WALL BOARD
with counterweighted column stand*



*VARIO WALL BOARD
with freely moveable column stand*

WALL BOARD



with castors



ceramic-steel and enamel-steel



FLIPCHART BOARD



with remote control



with castors and remote control

BOARD STAND

The polystyrol underlayer grants a more stable pinning surface.

FABRIC-COVERED AND CORK-SURFACED BOARDS

Fabric message board
COLOR SAMPLES



Puma blue



Puma red



Puma gray



Puma Yellow

STARTER KITS
included with the boards

CORK-SURFACE BOARDS:
100 pins, dowels, screws

FABRIC COVERED BOARDS:
100 pins, dowels, screws

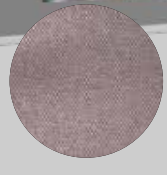
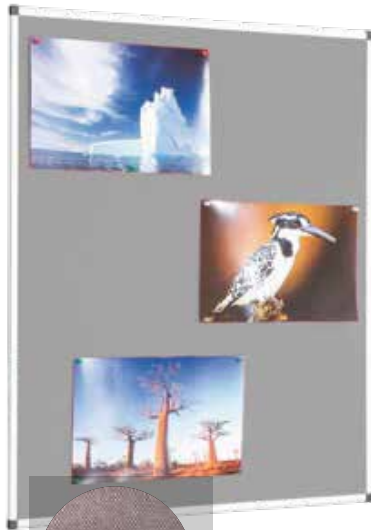

MESSAGE BOARD
with fabric cover

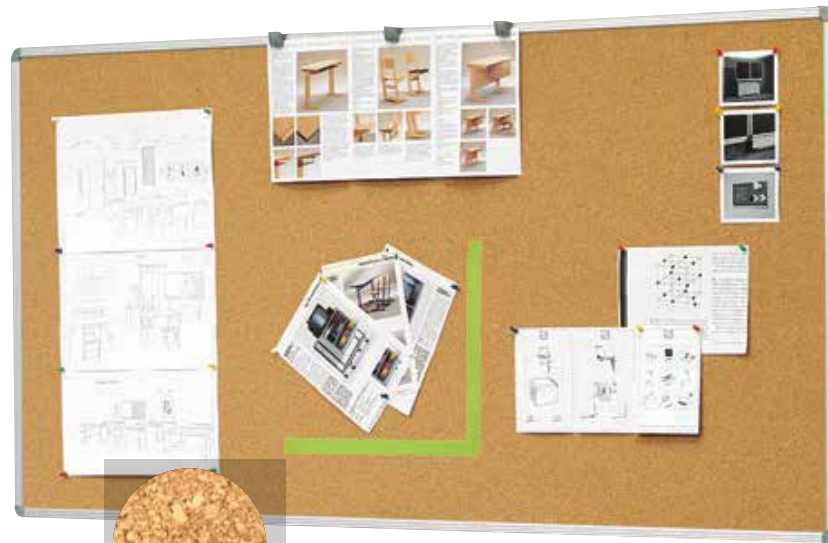

MESSAGE BOARD
with cork surface

MESSAGE BOARD

MODULAR



The modular display system is the perfect tool for setting up mobile installations and exhibitions quickly.

The swivelling board modules and the T-profile legs allow you to configure flat and spatial display systems for your exhibitions

For larger spaces, display-islands can be established.

The modules can be easily rearranged after assembly, using the T-stands optionally equipped with castors.

EASILY STORABLE IN SMALL SPACES WHEN DISASSEMBLED



120 cm wide

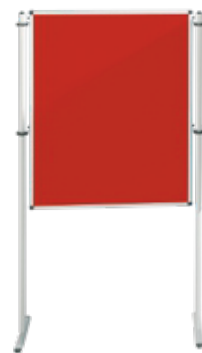

120 cm



150 cm



170 cm

DISPLAY SYSTEMS ⁵⁷



SPECIFIC
CLASSROOM
FURNITURES



SPECIAL FURNITURES

FOR CREATING
CLASSROOMS THAT MEET
UP TO DATE EDUCATIONAL NEEDS

We also manufacture special equipment for laboratories, technical workshops, IT and drawing rooms to help skill- and competency development.



SCIENCE

Our utility supply system provides an optimal solution for electrical, water, sewage and gas services for up to two workstations at the same time.

The safety of these electrical installations is guaranteed by emergency stop button, voltage indicator light, waterproof switch cabinet, as well as built-in small circuit breakers and contact protection Fi-Relé.

CUSTOMISABLE SUPPLY SYSTEMS



*PREMIUM CHEMICAL CABIN
one sided*



*SINGLE PERSON LAB DESK
with shelf*



*TWO PERSON LAB DESK
with shelf*



*THREE PERSON LAB DESK
with shelf*

LAB



ARTS WORKSHOP

Special furnitures are essential for the specialised classrooms.

For arts workshops we also manufacture specialised furnitures.

Our experts will help you find the right right design.

TOOLS FOR CREATIVE ACTIVITIES



*with sheet holder,
adjustable and tiltable*



melamine top



adjustable footrest

FURNITURES



OFFICE FURNITURE



UNIQUE & HIGHLY EFFICIENT OFFICE

TAILORED TO REQUIREMENTS

During design phase, we take into account in what type of environment office workers can do their job efficiently. Maintainable and smart office layouts.

Choose from our furniture range, and customise work environments for your individual needs.

During furnishing, we offer convenient options for arranging network cables and electrical wiring with mainline tools. Additionally, we modernise phone charging with built-in chargers.



For us, the office is not only a place for work, it is also a stage for creativity and teamwork.

TO LET THOUGHTS OPENLY FLOW, WE NEED TIDINESS AROUND US.

That is what the Pontis cabinet is best at: items, items not used at a time has to be stored orderly, whilst managing accessibility.

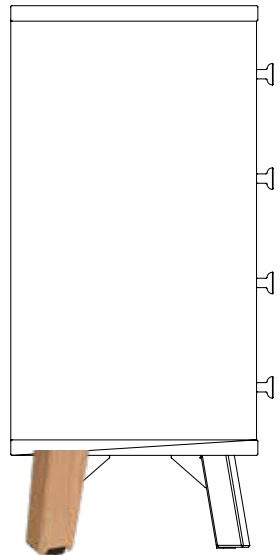

OAK legs

WE BROUGHT NATURE INTO THE OFFICE

Storage sizes of the Pontis cabinet were designed with the standard folder height in mind.

Cabinets are available in full laminated door, glass door & drawer, and wardrobe versions.

Lower Pontis sideboards open up space creating a warmer and more welcoming interior.



CABINETS



PONTIS

THE NEW DESIGN

The main principle behind the design of the Pontis Collection is to furnish multifunctional spaces with visual integrity.

By the natural textures of oil treated solid wood legs we bring nature in the office. Combining organic wood with steel creates a perfect combination and a lively environment.

SYMMETRICAL OR ASYMMETRICAL DESK

The legs of the Pontis desk have an angle of 75 degrees to the top.

90 angle and 75 angle

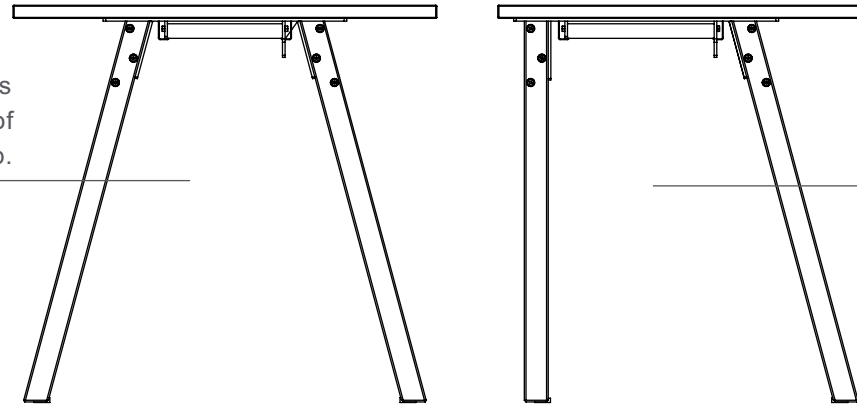

complementary products
PONTIS metal small drawer

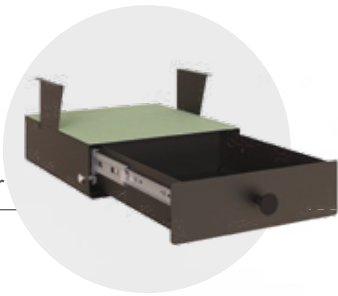

office chair



symmetrical



oval



rectangle

DESKS AND TABLES

FLYNN



A playful, lightweight design for creative thinking.

HARMONIC DESIGN

Wide selection of components, unlimited variation possibilities.

OPTIONAL ACCESSORIES:
front panel, screen, tidy cable, wireless charging pad

MANY SIZES, NEW SHAPES AND SELECTION OF COLOURS



container

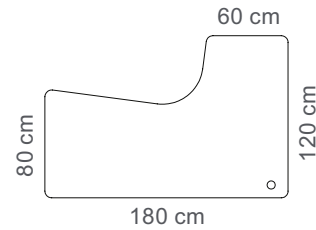

"L" left return

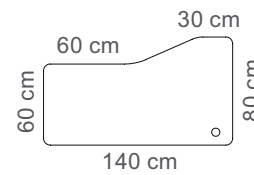

left side curved

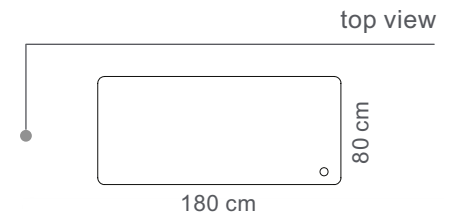

rectangular

DESKS



The ELEX height adjustable desks designed...

...FOR FLEXIBILITY AND ERGONOMIC COMFORT.

The dual-motor system provides faster movement and stability.

FOR HOME AND OFFICE, STANDING OR SITTING USE

125 cm

- ↳ stepless height adjustment
- ↳ dual-motor system

60 cm

- ↳ One-touch, 3 bank memory
- ↳ Safety stop mechanism, with collision detection.



with 2 motors for adjustable height



return desk, adjustable height



double-sided, adjustable height

DESKS



RELAX
WORK CAFE



SPACES DESIGNED TO HELP YOU GROW RECHARGE

No longer just a place to eat lunch and grab a coffee, the workplace café also serves as an area for collaboration and informal meetings.

Mobile technology makes it easier to work from anywhere, casual lunch conversation can easily turn into a brainstorming session.

Cafés need to be designed to accommodate changing work styles.



**WHEN AN EMPLOYEE TAKES TIME
TO RELAX AND EAT.**

Informal relationships between colleagues strengthens motivation and productivity.

Furthermore, the office canteen provides an excellent opportunity to enhance the company's identity and the relationship between employees and employers.

Here, the professional hierarchy can loosen up, allowing ideas and creativity to flow more freely.

CREATIVE SOLUTIONS



COFFEE STATION



MODULAR
STORAGE FURNITURE



ADVANCED STORAGE SYSTEM

MANY POSSIBILITIES

An excellent storage solution for locker rooms, work areas, dining rooms or community spaces. A popular solution among employees and employers.

With the combination of the standard size compartments and variable height units, you can create the most suitable combination adapted to different needs and characteristics.



MODULAR SYSTEM

Alex Furniture presents its newest cabinet module system, which provides a solution to any storage problem.

YOU DREAM IT

Thanks to a special, new technology, the melamine surface became printable.



CUSTOMISED GRAPHICS

THERE WILL BE ORDER!



AVAILABLE COLOURS



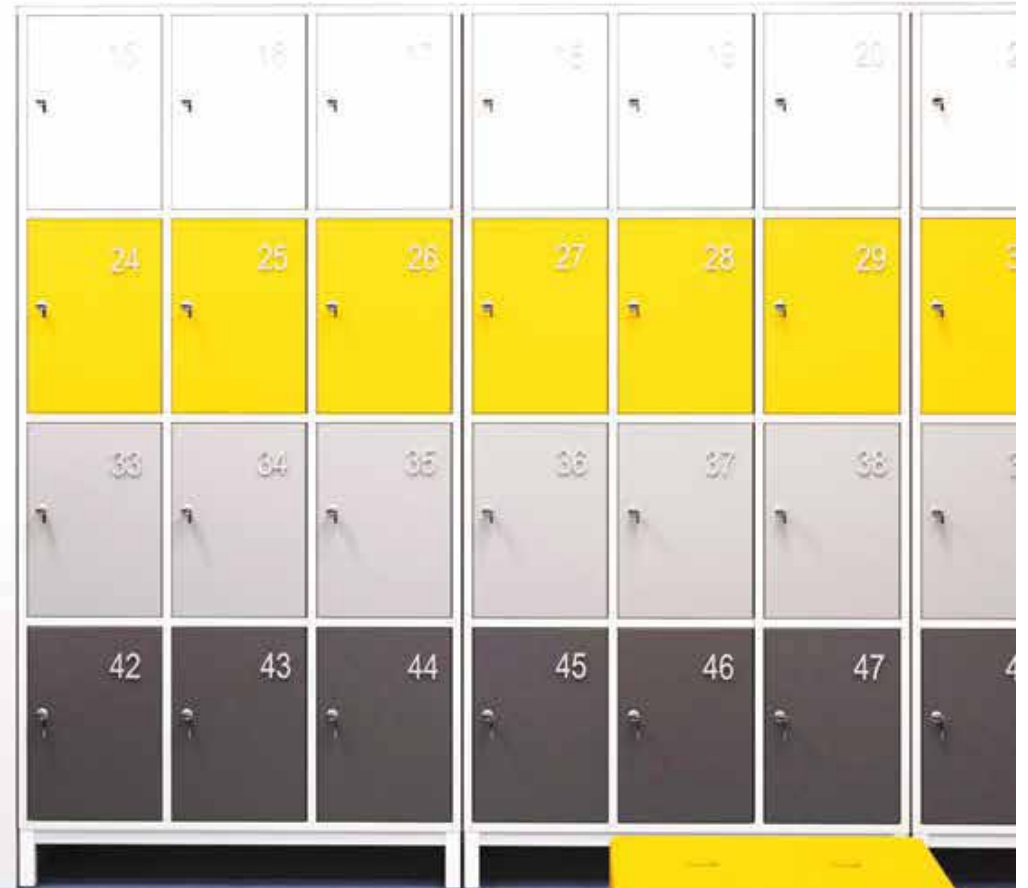

LOCKERS

MELAMINE FACED CHIPBOARD

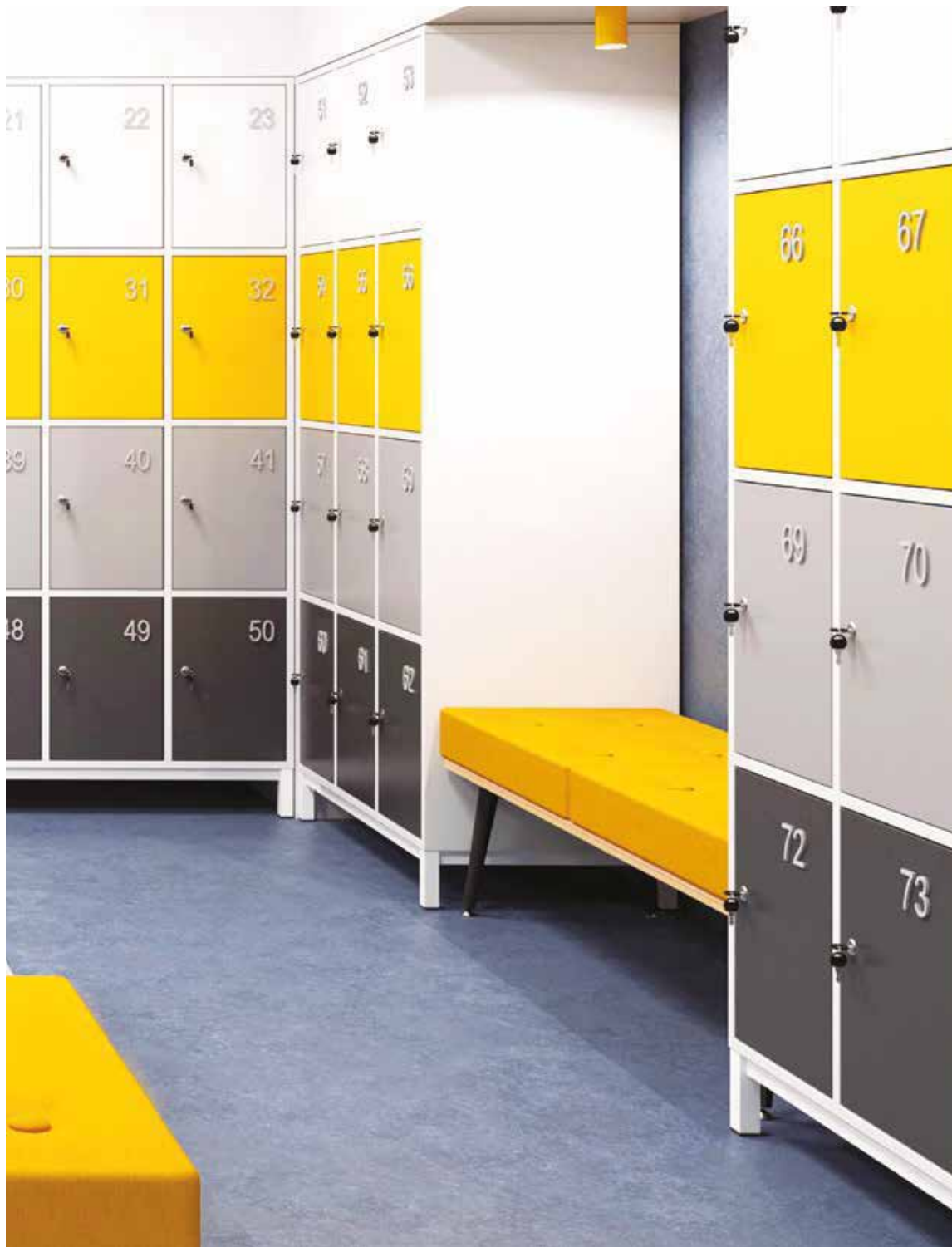

STABLE AND SAFE

WITH TWO KEY SECURITY LOCK

Our safe deposit boxes are perfect storages. When placed in the right space, it provides an individual storage option. It is made of melamine-faced chipboard.

The standardised 52 cm deep cupboards fit easily even in narrow spaces.

The back panel is made of solid chipboard, which makes the cabinet extremely stable and safe.

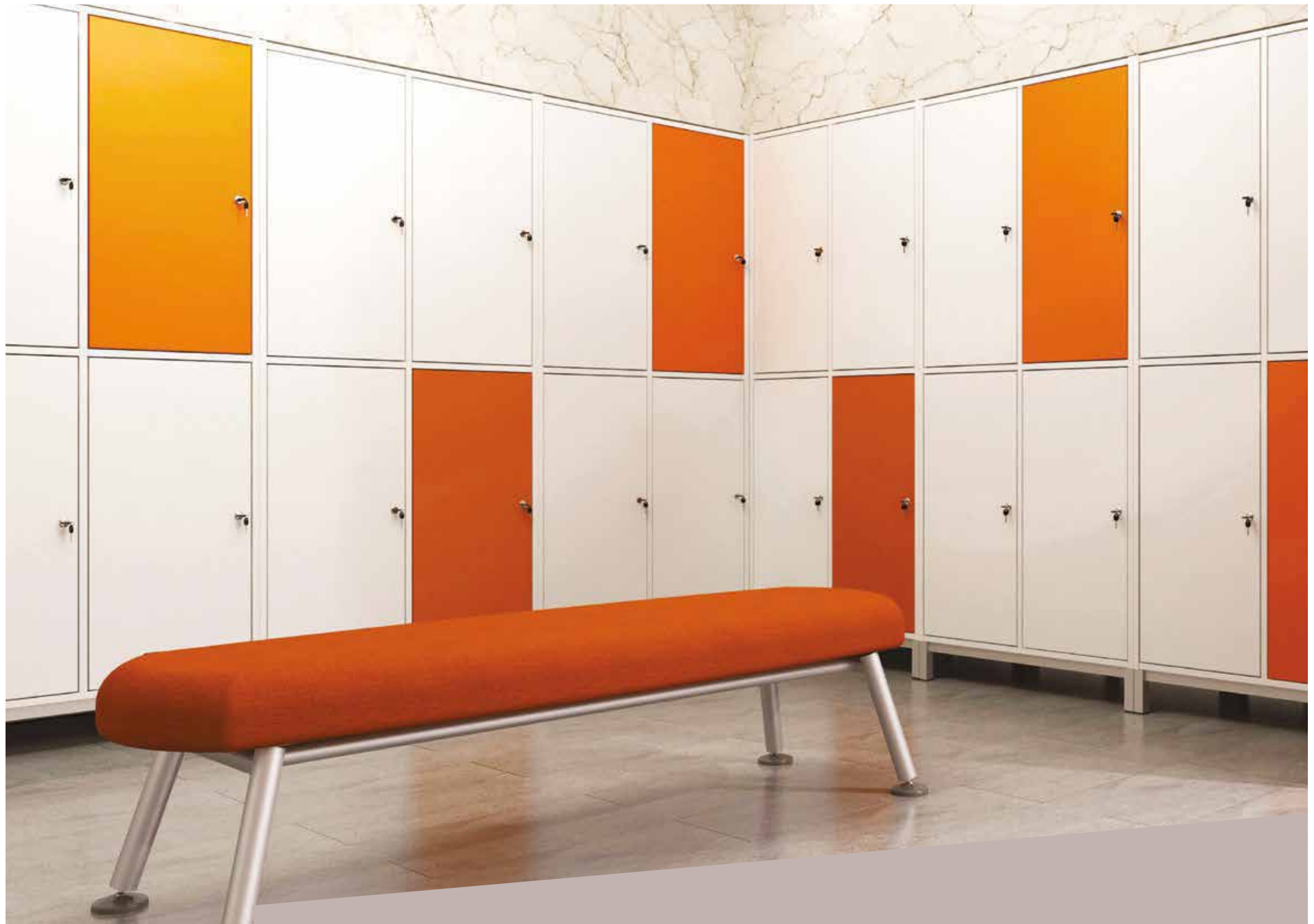



FITT LOCKER

MELAMINE FACED CHIPBOARD

UNIQUE SOLUTIONS

PRACTICAL DESIGN

The affordable cabinets are available to our customers in a wide range of colors and types.

The collection is highly customisable to meet different design expectations allowing to shape your own environment.

FITT WITH SHOE STORAGE LOCKER

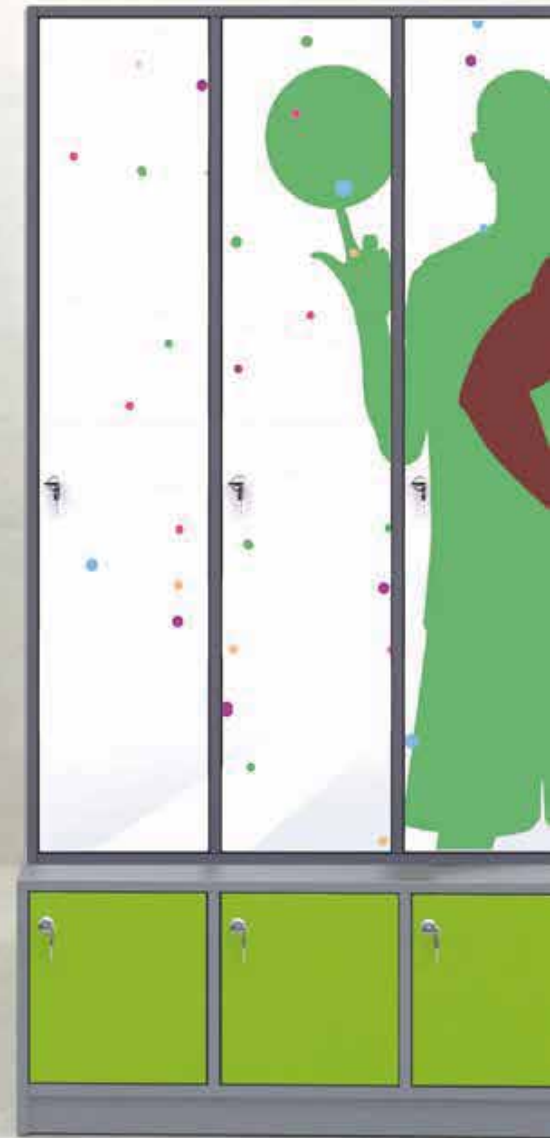

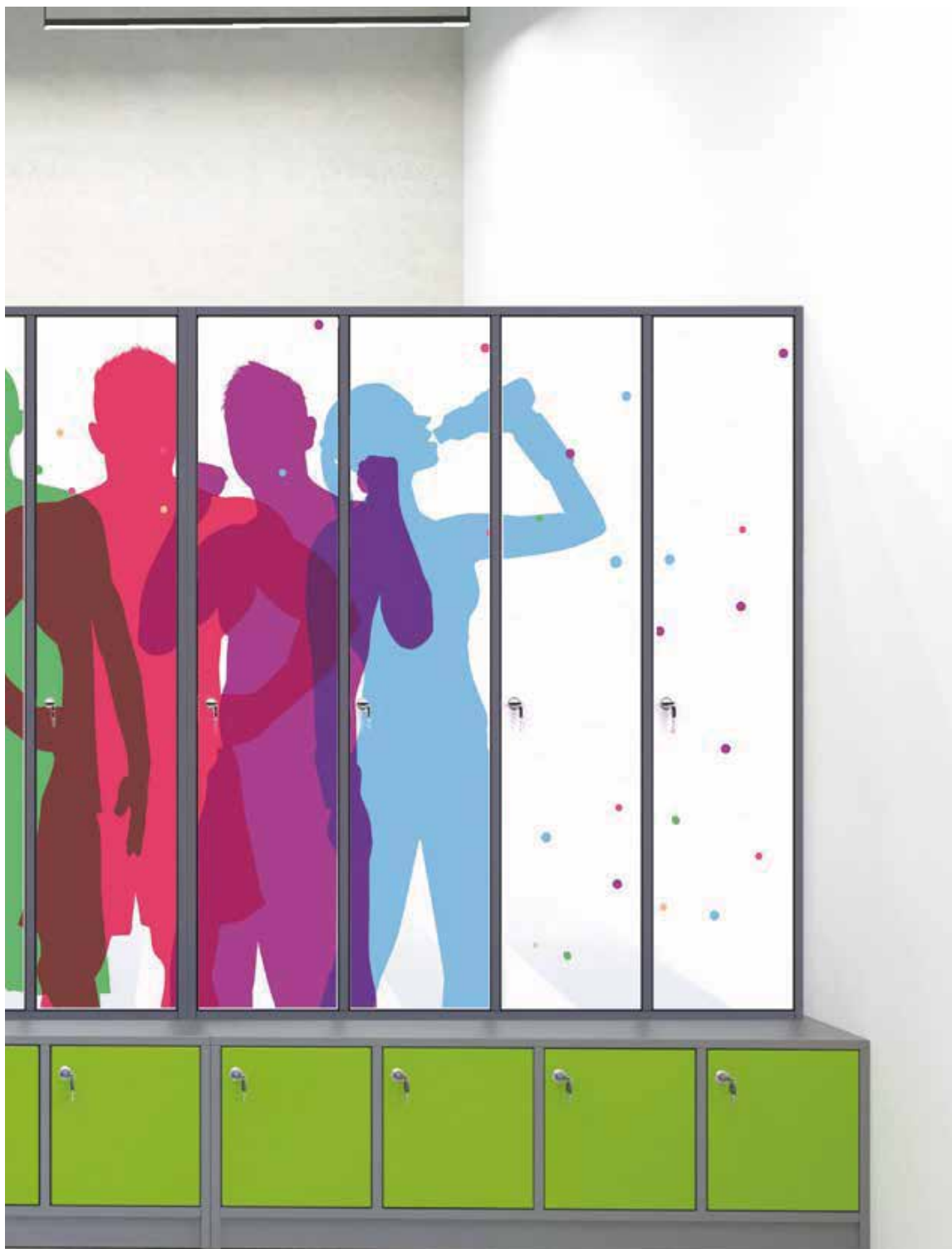

PRINTABLE FURNITURE SURFACES

WE MAKE YOUR DREAMS COME TRUE

A practical, space-saving wardrobe that meets all needs: it has a dedicated place for clothes, shoes and also accommodates a seating surface.

Shoes can be stored separately in the lower part.

Dream up your own graphic design and have it printed on the doors. A company logo, special locker numbering or a motivational print: various possibilities.



COMMON AREA
LOUNGE FURNITURES



CREATIVE AND PRACTICAL

OPTIMAL USE OF SPACE

Our environment constantly affects us. Every day shape our thinking and behaviour - even if we are not aware of it.

All of our products are suitable for furnishing reception areas, corridors, locker rooms, offices and lobbies.

We have designed furniture that fits well with each other, so there are countless variation options available for optimal use of space.



NATURAL DESIGN

The overall impression is often determined by small details.

The natural oak wood legs give the table a unique look, brings nature closer and give a feeling of fine luxury.

MULTIFUNCTIONAL TABLE

Flexible usage:
community space,
meeting and dining room

minimal design



PONTIS
coffee table



Universal look.
It adapts well to any style.

LOUNGE



COMFORTABLE, FUNCTIONAL
AND PRACTICAL

Comfort and design in the reception area, community space, office or meeting room.

Relax spot for taking a break, for tasks requiring concentration or for a phone call.

FREEDOM IN OPEN SPACE



BEAN LOBBY PLUS with screen
AB-LUX table



BEAN armchair with screen
DROP table



BEAN sofa with USB charger
BEAN table

LOUNGE



Our latest development is also unique in terms of material use and appearance.

CREATIVELY DESIGNED AND WELL FITTED BENCHES

The upholstered foam seat is fixed on a plywood layer. The table surface is a high-quality furniture linoleum giving it a soft touch and antistatic surface. Optional induction charger is available.

COMFORTABLE AND UNIQUE



phone charger and USB plug



narrowed pipe legs
chrome self-adjusting feet

AVAILABLE FOR ALL TYPES BENCHES



console table



LOUNGE



ATLANTA is an elegant furniture collection.

COMPOSITION OF GEOMETRIC SHAPES

The collection includes tables, armchairs, two- and three-seat sofas and benches.

MODERN AND ELEGANT

ATLANTA SOFA
3 seat,
powder coated legs



STRIKE TABLE
with metal leg,
in different sizes



ATLANTA TABLE
with metal legs

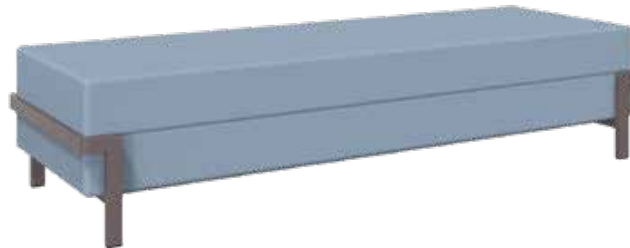

ATLANTA BENCH
3 seat



ATLANTA ARMCHAIR
1 seat

LOUNGE



With the lounge elements of our VITAL COLLECTION, locker rooms, hospitality areas and lobbies can also be furnished practically.

MODULAR BENCHES AND TABLES

Upholstered sofas can be complemented with benches, stools and low tables.

COLORFUL AND FUN SHAPE



COMPLEMENTARY PRODUCTS FOR ALL TABLE

phone charger and USB plug



VITAL STOOL
Size: Ø54x39 cm

VITAL lounge and coffee table elements



LOUNGE



**COMFORTABLE,
FUNCTIONAL AND PRACTICAL**

The BUBBLES Collection is the combination of comfort and design in a reception area, community space, office or meeting room.

INDOOR PLAYGROUND



BUBBLES 4.
size: 120x50x53 cm



BUBBLES 3.
size: 136x78x40 cm



BUBBLES 2.
size: Ø60x30 cm



BUBBLES 1.
size: 125,2x109,5x42 cm

LOUNGE



DURAN products are becoming more and more popular in public spaces, lounges and dining rooms.

**2 IN 1
LUNCH AND MEETING AREA**

High tables and bar stools are popular in workplace dining rooms as they offer versatile use.

DURAN Collection:
Tables, benches and stools, in high and regular furniture heights. Available in several sizes, colors and upholstery.



*DURAN
barstool*

**OPTIONAL
FOR ALL TABLES**

legs with castors

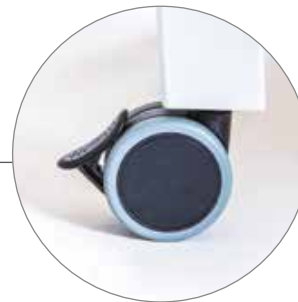

phone charger and USB plug



*DURAN
high table*

VARIABLE SPACE



LOUNGE



KOLD table multifunctional, meets different needs in any space.

NOT JUST FOR DINING...

The Scandinavian design goes well with any style.

A GREAT COMMUNITY SPACE



CROSS
barstool and stool

KOLD table
with CROSS barstool



LOUNGE



The modern-shaped Kaleido chair is produced in many colors.

VERSATILE KALEIDO COLLECTION

KALEIDO bar stools:

Chair backrest and seat in lacquered beech plywood or HPL covered plywood. Optional upholstered seat pad.



*KALEIDO
bar stool*

UNIQUE SHAPE, MODERN COMFORT



LOUNGE



DINING
CANTEEN FURNITURE



PRACTICAL ARRANGEMENT EASY TO CLEAN

Canteen furniture has to be durable, easy to clean and rearrange. It is essential to provide a comfortable seat for everyone and an opportunity to relax during a lunch break.



COLOURFUL DESIGN

TABLE:

The legs 40 mm diameter pipes, powder coated steel frame, 120 x 80 cm plywood top HPL covered both sides, plastic end cap. size: 120x75x80 cm

CHAIR:

The legs 18 mm diameter steel pipe with plastic gliders, seat and backrest HPL covered on both sides. size: 52x47x46 cm



II. DINING TABLE
vandalism-proof

KALEIDO DINING COLLECTION



KALEIDO
chairs

DINING



MINIMAL DESIGN

TABLE:

18 mm diameter steel pipe frame with plastic end cap. The table top: 1.8 cm melamine-faced chipboard, with ABS edging.

size: 135x75x90 cm

CHAIR:

The legs is a 12 mm diameter steel pipe, powder coated, upholstered seat and backrest.

size: 52x47x46 cm

BETA DINING COLLECTION



*BETA
dining table*



*BETA
chairs*

DINING

FLEX FLEX
FLEX



**VANDALISM-PROOF
ERGONOMIC DESIGN**

TABLE:

The legs 30 mm diameter powder coated steel pipe frame, plywood table top decorated on both sides.
size: 120x75x80 cm

CHAIR:

The legs 18 mm steel pipes, powder coated, unbreakable plastic shell. Size: 55x38x59 cm

FLEX DINING COLLECTION



FLEX CHAIR
vandalism-proof seat shell, spider legs



FLEX CHAIRS
various colours

DINING



REAL

DISTINCT SHAPES

TABLE:

Melamine-faced chipboard table top, tapered legs, powder-coated steel frame. size: 120x75x80 cm

CHAIR:

Electrostatically powder-coated steel frame, tapered legs, ply wood seat and backrest. size: 52x47x46 cm

REAL DINING COLLECTION



*REAL
dining table*



*REAL
chairs*

DINING

CUSTOM FURNITURE DESIGN



**DESIGN YOUR FURNITURE
WITH OUR SUPPORT!**

AGE GROUP CHART



At Alex Féműtor we follow **European Standard UNE-EN 1729 for schools** (chairs and tables for educational institutions), in which the functional dimensions (part I) and safety requirements (part II) of school furniture are regulated.

	1	2	3	4	5	6	7
Age of Child	AGE: 3-4	AGE: 4-6	AGE: 6-8	AGE: 8-11	AGE: 11-14	AGE: 14+	AGE: 16+
Child height	96 cm - 108 cm	108 cm - 121 cm	119 cm - 142 cm	133 cm - 159 cm	146 cm - 176 cm	159 cm - 188 cm	174 cm - 207 cm
Seating height	28 cm	30 cm	34 cm	38 cm	42 cm	46 cm	50 cm
Table height	50 cm	53 cm	58 cm	64 cm	70 cm	76 cm	82 cm

LAMINATED CHIPBOARD

	515 Light Arden Pine		U15559 Pastel Yellow		U18059 Gentian Blue		17500 Carmine
	24029 Fjord Beech		U15246 Mango		U18068 Heaven Blue		644 Beige
	577 Sonoma Oak		U15579 Yellow		U18079 Pacific		314 Light Grey
	551 Dark Plum		U16010 Orange		U19500 Star Fruit		304 Aluminium
	586 Chocolate Sonoma Oak		U16037 Powder		U19501 Apple Green		244 Petroleum
	404 Blossom Cherry		U16001 Sand Greige		U19502 Grass Green		103 White
	401 Savaria Beech		U17501 Rose		U19503 Avocado		
	463 European Maple		U17505 Plum		U19006 Mint		

POWDER COAT FRAMES AND L

	RAL 1006 Maize Yellow		RA Wa Blu
	RAL 1015 Light Ivory		RA Yel Gre
	RAL 1021 Colza Yellow		RA Pal Gre
	RAL 2004 Pure Orange		RA Ant
	RAL 3020 Traffic Red		RA Lig Gre
	RAL 4006 Traffic Purple		RA Wh Alu
	RAL 5024 Pastel Blue		RA Wh
	RAL 5019 Capri Blue		

ATED
LEGS

HPL CHAIRS AND TABLETOPS



FLEX SEAT SHELL

AGE GROUP 6



AGE GROUP 4

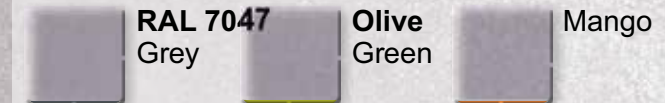

GRATNELLS TRAY

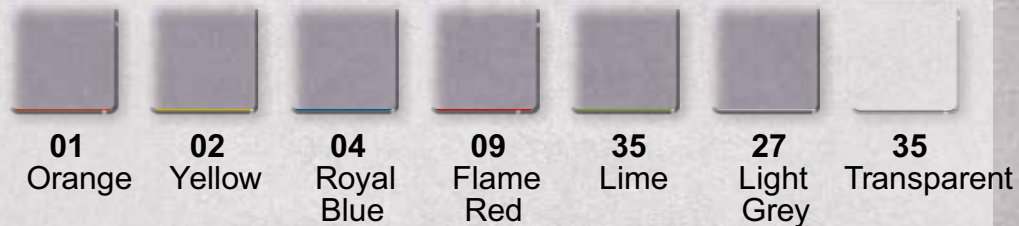

COMPACT PLAT



UPHOLSTERY

DAKOTA FABRIC



S-DA 001



S-DA 008

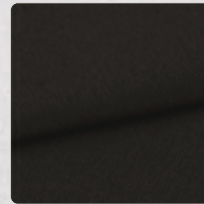

S-DA 100



S-DA 003



S-DA 010

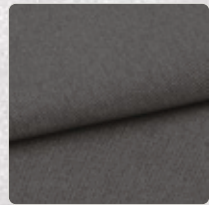

S-DA 013

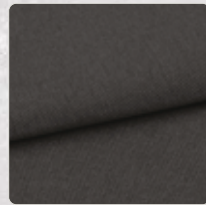

S-DA 014

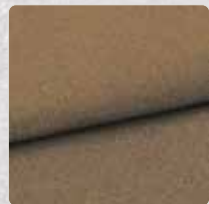

S-DA 024

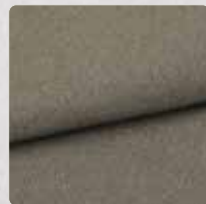

S-DA 091

OPTIO FAUX-LEATHER



Optio BA1



Optio BE5

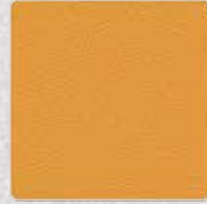

Optio P42



Optio BR2



Optio CE2



Optio CZ



Optio F504



Optio N502



Optio N8

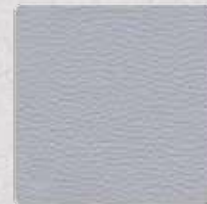

Optio SA3



Optio SA4



Optio Z7

SEALIFE FABRIC

MADE WITH SEAGUAL YARN
100% RECYCLED MARINE POLYESTER

OEKO-TEX®
CONFIDENCE IN TEXTILES
STANDARD 100

 Sealife 1506	 Sealife 3509	 Sealife 4522
 Sealife 4528	 Sealife 6512	 Sealife 7525
 Sealife 8517		

BONDAI FABRIC

OEKO-TEX®
CONFIDENCE IN TEXTILES
STANDARD 100

 Bondai 1005	 Bondai 1008	 Bondai 8078
 Bondai 3005	 Bondai 3012	 Bondai 4007
 Bondai 4011	 Bondai 6006	 Bondai 6015
 Bondai 7008	 Bondai 7048	 Bondai 8010

ZEN FABRIC

 0002	 07459
 20127	 20154
 20319	 20320
 5015	 5349